

NON-METALLIC CONNECTOR SERIES (Glass Reinforced Epoxy) VISUAL INDEX

XSJJ SERIES SUPERSEDES THE XSJ SERIES

XSEE SERIES SUPERSEDES THE XSE SERIES

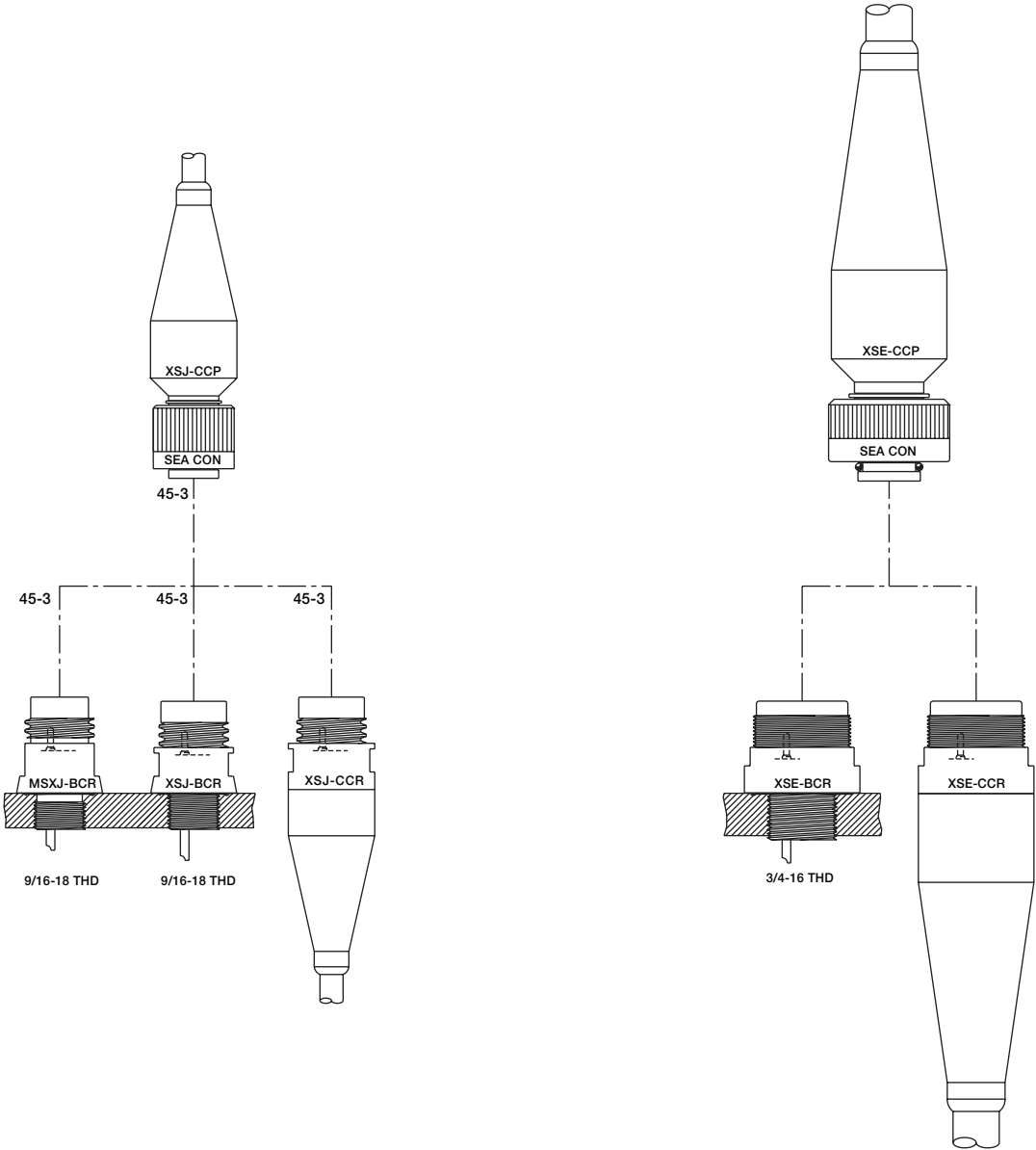

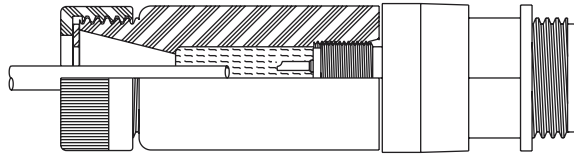

XSL-CCR-FI
45-9

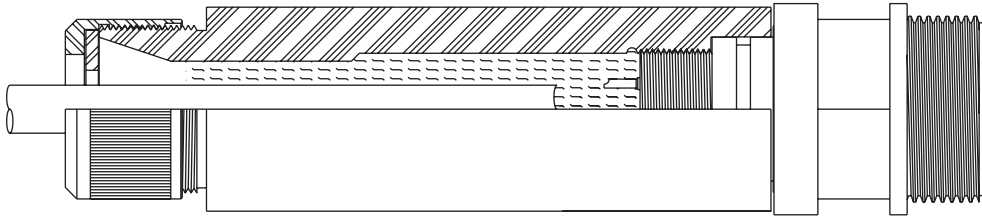

XSM-CCR-FI
45-9



45-4

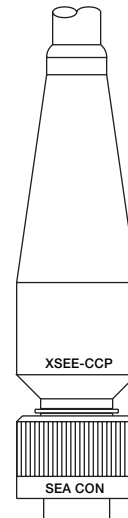

45-1

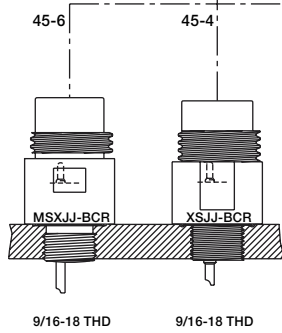

45-6

45-4

45-5

9/16-18 THD

9/16-18 THD

XSJJ-CCR

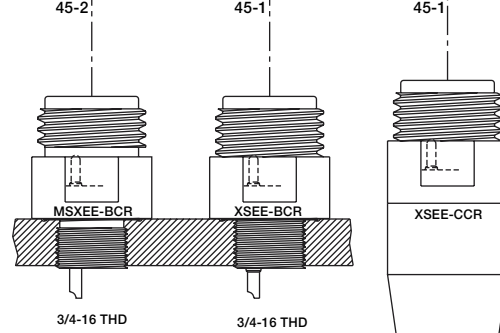

45-2

45-1

45-1

3/4-16 THD

3/4-16 THD

XSEE-CCR

NOTE: Torque values referenced in this literature assume installation into dry metal threads. Please contact the factory for recommendations.

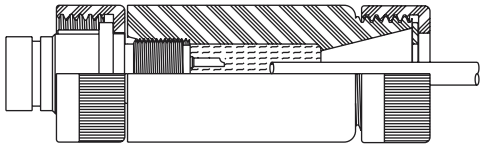

XSL-CCP-FI
45-9

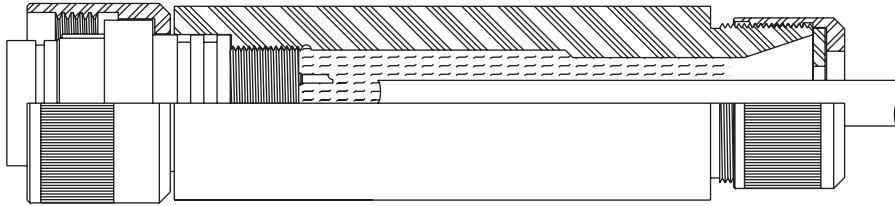

XSM-CCP-FI
45-9

